



STYLAM INDUSTRIES LIMITED

CORPORATE OFFICE

S.C.O. 14, Sector 7-C,
Madhya Marg, Chandigarh (UT)
INDIA - 160019

T: +91-172-502 1666

F: +91-172-502 1495

E: info@stylam.com / inquiry@stylam.com

www.stylam.com



FIRST
INDIAN MANUFACTURERS WITH
1860 X 4320 mm PANEL SIZE



CELEBRATING



YEARS

VISION

To maintain and strengthen our position nationally and globally in Home Décor space with an array of new innovative products and adding value to life.

MISSION

We are committed to being the market leader by constantly innovating and delivering newer products and services.

We aim to set the highest possible standard in quality, value and customer satisfaction.

33 years spent pursuing the ethos, 'what the spirit commits, perseverance completes' is what has shaped Stylam Industries Limited. Incepted in the year 1991 under the name of Golden Laminates Private Ltd, we started our success story by manufacturing decorative laminated sheets for both residential as well as industrial applications. Today, under the brand name STYLAM we have been combining industrious efforts, wide experience and innovative product customization to consistently deliver quality and satisfaction to our clients. Dealing in post forming, anti-static, anti fungal and anti bacterial and chemical resistant laminates, Stylam is a name trusted for unmatched laminates that suit every budget. We are reputed to be a global entity with a Pan India presence and a thriving export market in more than 60 countries. Our major customers are in Europe, Far East, Middle East, Russia & North America and we continue to maintain robust YOY growth.

We have our state-of-the-art infrastructural plant at Panchkula in North India. Our manufacturing unit has world-class machines and equipments and assures maximum production of laminates in minimum time and our machines are operated by highly skilled and best in the class workmen. Since 33 years, we have been developing high quality products. Sophisticated moulds of various finishes imported from Europe are used in the production of our high quality laminates in accordance with

the universally acceptable European standards EN 438 series. Marking our silver jubilee celebrations is the inauguration of our second production facility, this is an ultra modern manufacturing plant designed by renowned Singapore based architects. The factory is spread over 25 acres and has been designed considering the most modern structural concepts. The facility will have a hydraulic press system capable of producing the biggest size of laminate panels in India at 4320 x 1860 mm. Jointly our production facilities will ensure that we become the largest laminate producing group in India with a production capacity of over 17 million laminates.

We are an ISO 9001:2008 certified company, that itself shows our integrity, quality and reliability. Another feather in our cap is, we are recognized as an 'Export House' by the Government of India. Our unique design range and advanced quality efficiency of laminates has assisted the company in being awarded the prestigious CE certification for its compact laminates.



**FUELLED BY
INTELLIGENCE,
THE PASSION
TO EXCEL.**



Company overview

CUBOID overview **01**

Washroom Cubicles **03**

Urinal Partitions **13**

Support Grab Bars **13**

Locker Systems **15**

CUBOID advantages **18**

Cubicle formats at a glance **19**

Accessories Grocery **21**

The Certificates **22**

Technical Data **23**

ABOUT CUBOID

Stylam presents CUBOID - a modular restroom and locker cubicle systems. CUBOID range is crafted using the finest materials and highest quality fixtures and fittings specially for heavy traffic areas where functionality and durability matters most. Our focus is on offering high-quality products that meet the specific demands of restroom applications in commercial, hospitality healthcare, education, transport, sports & wellness and leisure sectors.

CUBOID has an exhaustive range that is stylish, sturdy yet affordable and is available in various formats, shapes and surface designs. Besides, our cubicle systems come in special dimensions that take care of the needs of the physically challenged individuals. Anti-bacterial and anti-fungie properties of the laminate surface minimise the risk of spreading and transferring bacteria.

THE NOTION OF MODULAR CUBICLE SYSTEM

Modular cubicles are one of the most cost-efficient and modern concepts in restroom designing. These cubicles are made from Compact Grade Laminate (CGL). Compact Solid Grade laminate is a self-supporting decorative panel with a black core offering the same surface advantages as those of HP. This product is particularly apt for high humidity environments due to its inherent water resistance.

All Stylam Compact Laminates come with the Germ-Free protection Shield of "Anti-Bacterial & Anti-Fungie" at no additional cost. Perfect for sensitive (humidity, heat) and high traffic environments (Schools, hospitals etc.), the Germ-Free Shield ensures continuous protection against the development and proliferation of bacteria. Germ-free shield guarantees a safe and hygienic surface (99.9% effective).



EXCLUSIVE Range FIRE GAURD

WHY FIREGUARD?

Secure your space with confidence, as FireGuard's main USP lies in its unwavering commitment to fire safety, setting it apart from the rest.

Ideal for Various Sectors: Tailored for commercial, hospitality, healthcare, education, transport, sports & wellness, and leisure sectors, FireGuard delivers unparalleled safety without compromising on style.



UNMATCHED FIRE RETARDANT TECHNOLOGY: Elevate safety standards with cutting-edge fire-resistant properties, ensuring your space is shielded from potential hazards.



Premium Quality Construction: Crafted using the finest materials and top-tier fixtures, FireGuard stands the test of time in heavy traffic areas.

Stylish Durability: A fusion of style and sturdiness, FireGuard offers an extensive range of formats, shapes, and surface designs, all while prioritizing safety.

Inclusivity: Specially designed dimensions cater to the needs of differently-abled individuals, ensuring accessibility for everyone.

SECURE. STYLISH. SUPERIOR.

The Pinnacle of Fire-Resistant Restroom and Locker Solutions by Stylam. Crafted with precision, FireGuard ensures unparalleled functionality and durability, tailored for heavy traffic areas where safety is paramount.

FireGuard, a revolutionary offering by Stylam, stands as the epitome of safety and style in the realm of modular restroom and locker cubicle systems. Its main USP lies in its cutting-edge fire retardant technology, ensuring an unprecedented level of protection against potential hazards. Crafted with the utmost precision using top-tier materials and fixtures, FireGuard remains steadfast in heavy traffic areas, where functionality and durability are paramount. Its stylish yet robust design, available in various formats, shapes, and surface designs, seamlessly integrates safety without compromise. Furthermore, FireGuard embraces inclusivity with specially designed dimensions catering to the needs of differently-abled individuals, making accessibility a priority.

Tailored for commercial, hospitality, healthcare, education, transport, sports & wellness, and leisure sectors, FireGuard goes beyond expectations to meet the unique demands of diverse environments. Secure your space confidently with FireGuard, where each cubicle guarantees an exceptional level of fire safety. Contact us today and let FireGuard redefine safety standards in your spaces—where every moment is safeguarded with style and distinction.

Choose FireGuard for a revolution in fire-retardant restroom and locker solutions that prioritize safety without compromising on aesthetics.

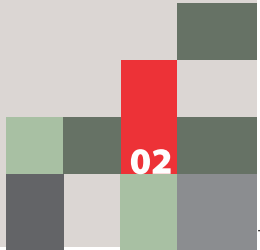

CUBICLE SYSTEMS



disadvantages of wet system

- Cleaning of floor becomes difficult
- Dirt and stains easily settle down on the bottom because of its porous surface
- Tile designs can go out of production making its replacement difficult
- Since the grout joints are porous they can easily absorb pungent smell
- Loss of space-Usage of 6' x 6" thick walls result in loss of 3 sq.ft area per partition
- Load of building is high
- No means of natural ventilation is provided

advantages of dry system

- Economy of space-The partition panels are only 12mm or 18mm thick as compared to 150mm thick brick wall
- Economy of load-Partitioning systems reduces the load on building as compared to the usage of brick wall
- Reduced installation time-4 cubicles can be setup in a day
- Neatness-Since no wet work is involved
- Proper air ventilation access is provided in the designs
- Easy floor cleaning-Absence of corners doesn't let the dust to accumulate on the floor
- Vibrant range-Available in different colours and patterns

MATERIAL CONFIGURATION

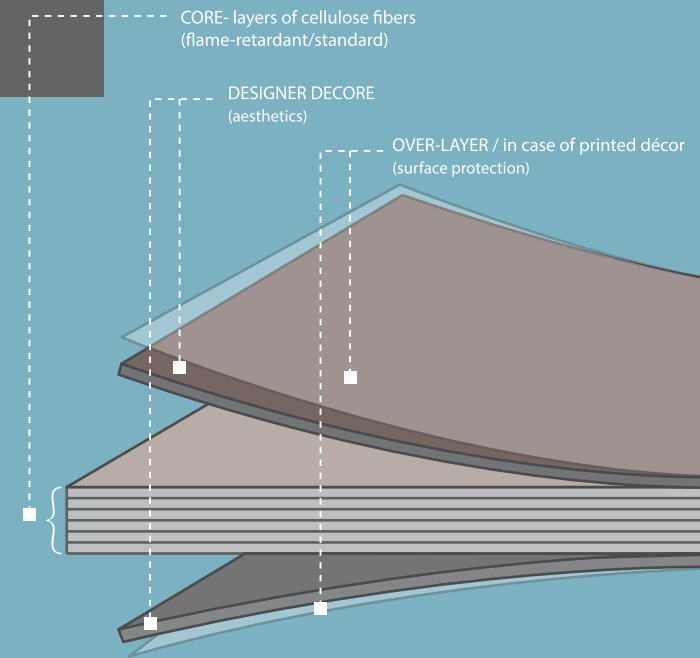

compact solid grade laminate board

The compact board comprises of cellulose fibrous material (generally paper). The core is made up of layers of cellulose fibers impregnated with thermosetting Phenolic Resin and the decorative design paper on both sides impregnated with special melamine resin is manufactured under the combined application of heat (1550 C) and high pressure (specific pressure: 9 MPa/90 Bar) in a multi daylight press in which resin poly condensation takes place to give the product that extra performance through & through - strength, durability and toughness. The board is manufactured as per IS 20146.

hardware system



SS Legs



SS Shoe Box-up



Top Rail

CUBOID from STYLAM offers you an assortment of hardware fittings that endeavor to provide you with pleasing aesthetics and superior performance at an economical price. Crafted from high quality imported materials, these hardware fittings are available in polyamide, stainless steel and aluminum finishes. Within the stainless steel hardware, CUBOID offers you with two distinct variants:

- SS Grade 304 is the most versatile '18/8' stainless steel. Its malleable and ductile nature is due to its superior forming and welding characteristics. While drawing thin sheets, intermediate and post weld annealing is not needed on this grade.
- SS Grade 316 with its added content of Molybdenum and higher amount of nickel, gives

you a better quality of stainless steel that's corrosion resistant and enduring. The SS 316 performs well in sub-zero conditions and aggressive

conditions like sea water, chloride contaminated media and acetic acid vapors. With higher strength, the SS 316 has better pitting, crevice and creep resistance to corrosion.

PRO series DURA

Simplicity is the ultimate sophistication, personified by the **DURA/PRO series** of cubicle systems. These systems come in high endurance compact laminates in multiple designs with solid stainless steel top rails and adjustable legs for efficient floor clearance.

All accessories like hooks, hinges, door knobs are in stainless steel. This series is perfect for high traffic areas like shopping malls, offices, or hospitals where one strives for simplicity, elegance and functionality.

PROPOSED APPLICATION AREAS

- commercial**
offices / shopping malls / commercial complex
- hospitality**
restaurants
- healthcare**
hospitals / clinics
- sports**
stadium / sports clubs / gym / club houses

CUBICLE SYSTEMS



THE STRUCTURE

- The adjustable legs (SS Grade 316) provided in the DURA series are anchored to the floor so that mid/end pilasters could be fixed on them.
- The base of leg is anchored to the floor with nylon plugs that are inserted into ground with SS screws
- The adjustable legs provide floor clearance of 150 mm.
- The top rail (SS Grade 304) is fixed to maintain alignment of all pilasters (mandatory in 12 mm model)
- Intermediate Panels (partitions) are fixed to rear wall and mid pilaster through SS U-channels.
- Maintaining the floor clearance of 150 mm, each door is mounted on mid/end pilaster with 3 hinges.
- Each door has one coat hook and door knob affixed.
- Door opening could be set either from inside or outside and could be fixed on left or right side.

DIMENSIONS

Standard dimensions (mm)	Regular	Specially abled
Total cubicle height from ground	2065	2065
Cubicle depth	1550	1550
Pilaster height	1860	1860
Pilaster width	150/300	150/300
Door height	1860	1860
Door width	600	900
Top rail height	55	55
Bottom gap	150	150
HPL Thickness	12	12

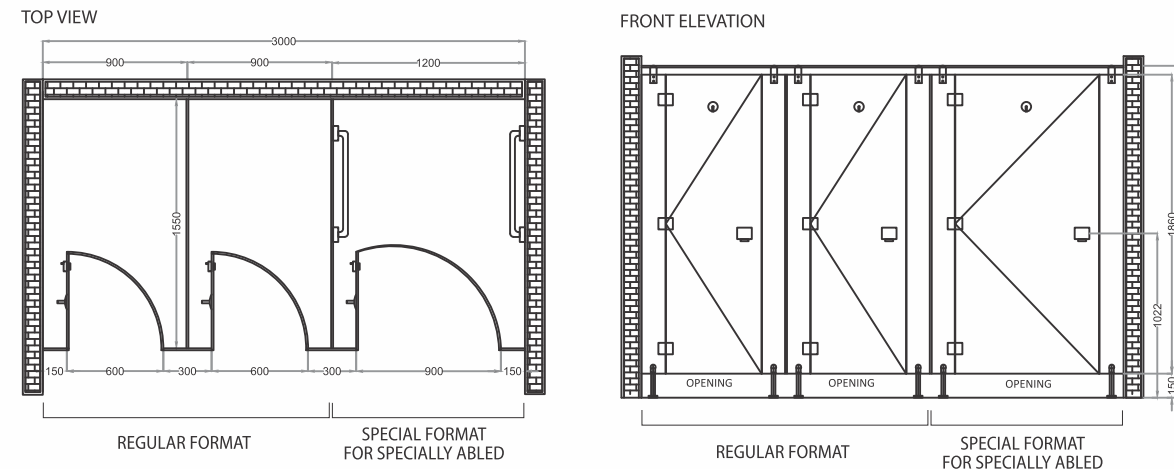

SS Top rail



Privacy indicator/Knob



Coat hook



Adjustable SS Legs

SPECIAL FEATURES

- Adjustable SS legs
- SS Top rail arrangement for better stability, strength and aesthetics
- SS accessories

PRO series MAX

Magnificent design is a way of life with the **MAX/PRO series** of cubicle systems. These systems come with adjustable stainless steel legs that are anchored to the floor giving you high floor clearance for effective cleanliness. Anodized, aluminum top rails provide you with high endurance, functional capability. All cubicle accessories are in stainless steel. These rich in design, high strength, and economical systems are your go-to choice for high traffic areas.

PROPOSED APPLICATION AREAS

- commercial**
offices / shopping malls / commercial complex
- hospitality**
restaurants
- healthcare**
hospitals / clinics
- sports & wellness**
stadium / sports clubs / gym
spa / club houses
- education**
schools / collages / universities

CUBICLE SYSTEMS

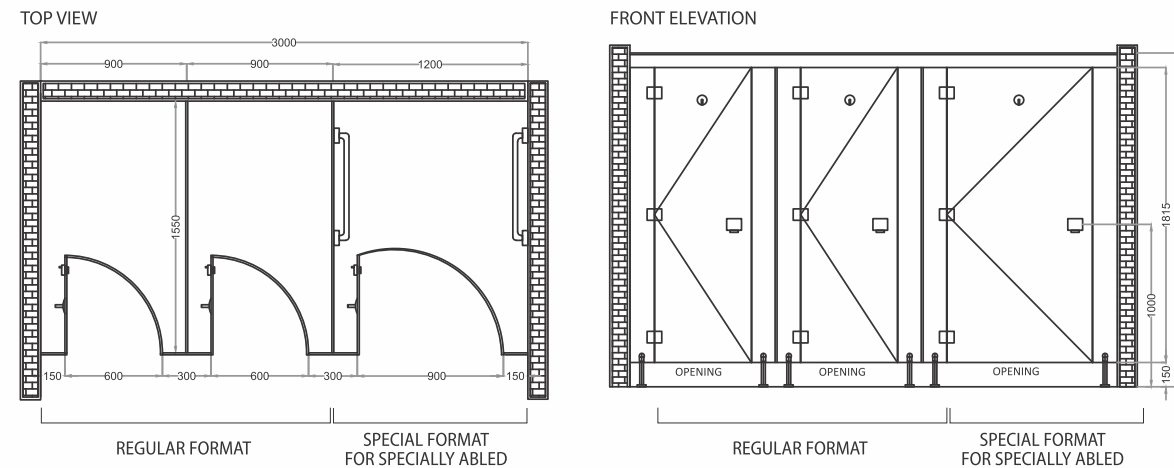

DIMENSIONS

Standard dimensions (mm)	Regular	Specially abled
Total cubicle height from ground	2055	2055
Cubicle depth	1550	1550
Pilaster height	1860	1860
Pilaster width	150/300	150/300
Door height	1815	1815
Door width	600	900
Top rail height	45	45
Bottom gap	150	150
HPL Thickness	12	12

THE STRUCTURE

- The adjustable legs provided in the PRO series are anchored to the floor so that mid/end pilasters could be fixed on them.
- The base of leg is anchored to the floor with nylon plugs that are inserted into ground with SS screws
- The adjustable legs provide floor clearance of 150 mm.
- The extruded anodized aluminum top rail is fixed to maintain alignment of all pilasters
- Intermediate Panels (partitions) are fixed to rear wall and mid pilaster through aluminum U-channels.
- Maintaining the floor clearance of 150 mm, each door is mounted on mid/end pilaster with 3 hinges.
- Each door has one coat hook and door knob affixed.
- Each mid/end pilaster coming at the free end of the door is furnished with one privacy thump-turn and one door stopper channel to reduce the noise.
- Door opening could be set either from inside or outside and could be fixed on left or right side.

SPECIAL FEATURES

- Adjustable SS legs
- Natural Anodizing aluminum Top rail arrangement for better stability and economy
- SS accessories (hinges, coat hook, adjustable foot, lock set/latch indicator etc)

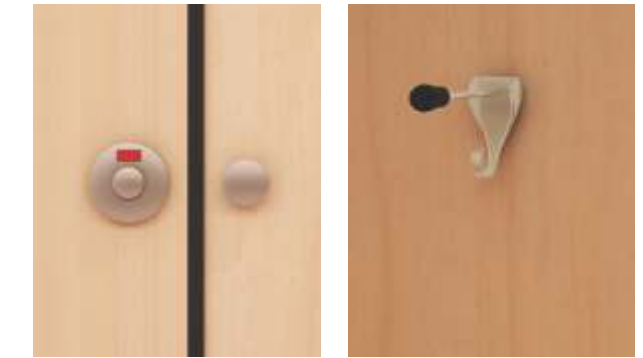

Privacy indicator/Knob SS Coat hook



Anodizing aluminum Top rail



Adjustable SS Legs

PRO series LORON

BOX-UP 12mm

Enhance the beauty of your restrooms with the **LORON/PRO series** of cubicle systems. This 12 mm shoe box up series gives your restroom area an elegant, contemporary and clean look. Laminates for these cubicles come in magnificent colours and designs with stainless steel top rails that provide stability and strength. All accessories like hooks, hinges and door knobs are in stainless steel. This series works well for high end commercial spaces, specialty hospitals, spas and club houses.

PROPOSED APPLICATION AREAS

- commercial**
plush offices / high end shopping malls
- hospitality**
restaurants / hotels
- healthcare**
high end hospitals
- sports & wellness**
spa / club houses

CUBICLE SYSTEMS



THE STRUCTURE

- SS Shoe Box (Grade 316) provided in the PRO series is anchored to the floor so that mid/end pilasters could be fixed on them.
- The pilaster is supported by L-bracket floor anchor bolt which is concealed with 100 mm high SS Shoe Box
- The Shoe Box provides floor clearance of 100 mm.
- The top rail (SS Grade 304) is fixed to maintain alignment of all pilasters (mandatory in 12 mm model)
- Intermediate Panels (partitions) are fixed to rear wall and mid pilaster through SS U-channels.
- Maintaining the floor clearance of 100 mm, each door is mounted on mid/end pilaster with 3 hinges.
- Each door has one coat hook and door knob affixed.
- Door opening could be set either from inside or outside and could be fixed on left or right side.

DIMENSIONS

Standard dimensions (mm)	Regular	Specially abled
Total cubicle height from ground	1915	1915
Cubicle depth	1550	1550
Pilaster height	1860	1860
Pilaster width	150/300	150/300
Door height	1760	1760
Door width	600	900
Top rail height	55	55
Bottom gap	100	100
HPL Thickness	12	12

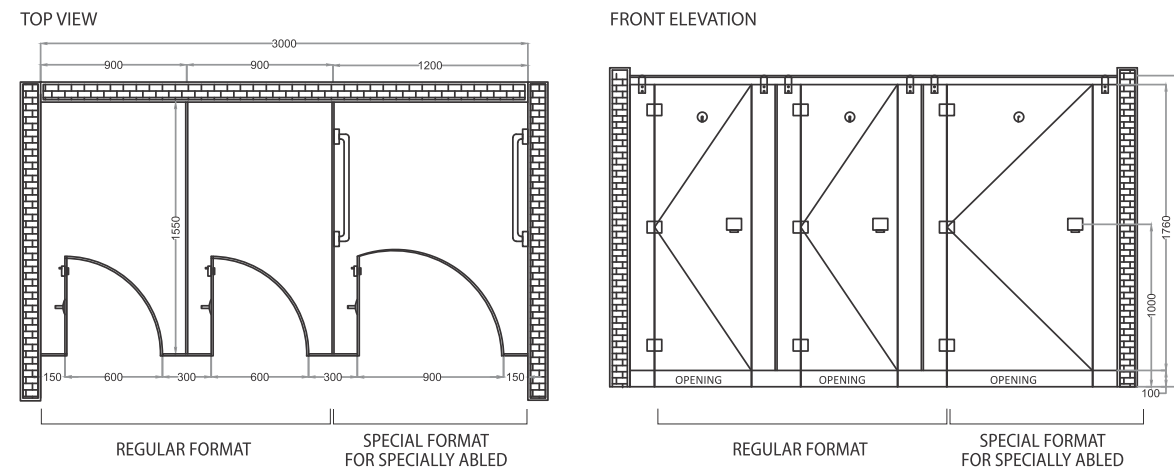

Privacy indicator/Knob

Coat hook



SS Top rail



SS Shoe Box Up - 12 mm compact board

SPECIAL FEATURES

- SS Shoe Box Up arrangement at bottom enhances the overall beauty of the restroom area
- SS Top rail arrangement for better stability and strength
- SS accessories

PRO series LANTO

BOX-UP 18mm

Fine design sensibility coupled with magnificence has a new name with the **LANTO/PRO series** shoe box up cubicle system. Formulated with 18mm thick compact laminates that provide extra sturdiness and durability, one can do away with the top rails if desired. The cubicle accessories are in stainless steel with each door having one privacy thumb-turn and one door-stopper channel for a noise free experience. This series with its flexibility, durability and enhanced sturdiness works well in high end commercial spaces, plush offices, restaurants and luxury spas.

PROPOSED APPLICATION AREAS

- commercial**
plush offices / high end shopping malls
- hospitality**
restaurants / hotels
- healthcare**
high end hospitals
- sports & wellness**
spa / club houses

CUBICLE SYSTEMS



THE STRUCTURE

- SS Shoe Box (Grade 316) provided in the PRO series is anchored to the floor so that mid/end pilasters could be fixed on them.
- The pilaster is supported by L-bracket floor anchor bolt which is concealed with 100 mm high SS Shoe Box
- The Shoe Box provides floor clearance of 100 mm.
- Intermediate Panels (partitions) are fixed to rear wall and mid pilaster through SS U-channels.
- Maintaining the floor clearance of 100 mm, each door is mounted on mid/end pilaster with 3 hinges.
- Each door has one coat hook and door knob affixed.
- Each mid/end pilaster coming at the free end of the door is furnished with one privacy thumb-turn and one door-stopper channel to reduce the noise.
- Door opening could be set either from inside or outside and could be fixed on left or right side.

DIMENSIONS

Standard dimensions (mm)	Regular	Specially abled
Total cubicle height from ground	1870	1870
Cubicle depth	1550	1550
Pilaster height	1860	1860
Pilaster width	150/300	150/300
Door height	1715	1715
Door width	600	900
Top rail height	45	45
Bottom gap	100	100
HPL Thickness	18	18

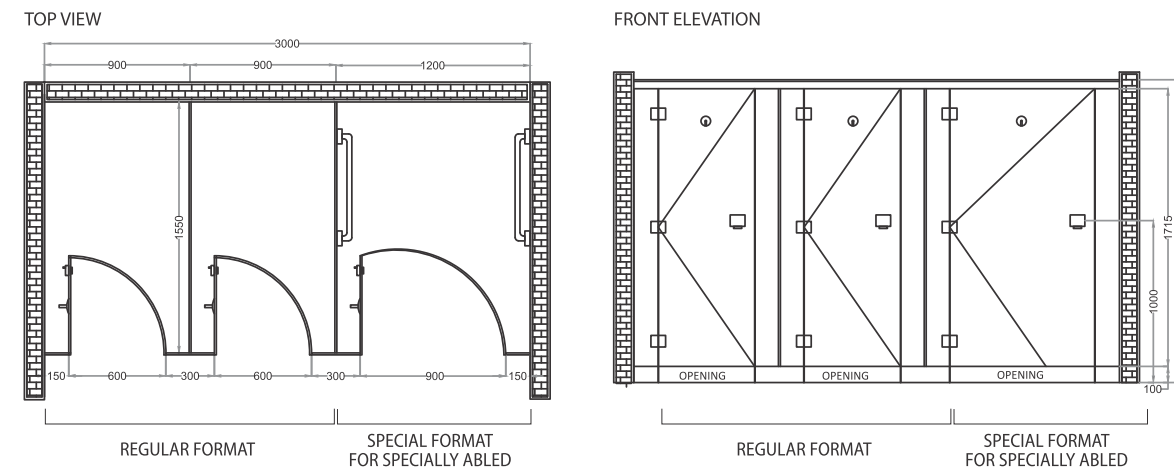

Privacy indicator/Knob

SS Coat hook



SS Top rail



SS Shoe Box Up / 18 mm compact board

SPECIAL FEATURES

- SS Shoe Box Up arrangement at bottom enhances the overall beauty of the restroom area
- 18 mm thick Compact Board makes the entire setup sturdier
- SS Top rail arrangement for better stability and strength (optional in this model)
- SS accessories

PROseries HANG UP

Presenting the flawless floating format with smooth aesthetics and contemporary persona – The Hang UP/Pro series. This is a ceiling hung model to give your washroom the futuristic look along with a hassle free cleaning hygiene maintenance. The cubicle accessories are in stainless steel with each door having one privacy thumb-turn and a doorstopper channel for the noise free experience. This series with its clear-floor neat modern look and durability works well in premium commercial spaces and malls, sports and health clubs, gyms, spas etc.

PROPOSED APPLICATION AREAS

- commercial**
premium offices / high end shopping malls
- healthcare**
high end hospitals
- sports & wellness**
spa / sports clubs / gym

CUBICLE SYSTEMS

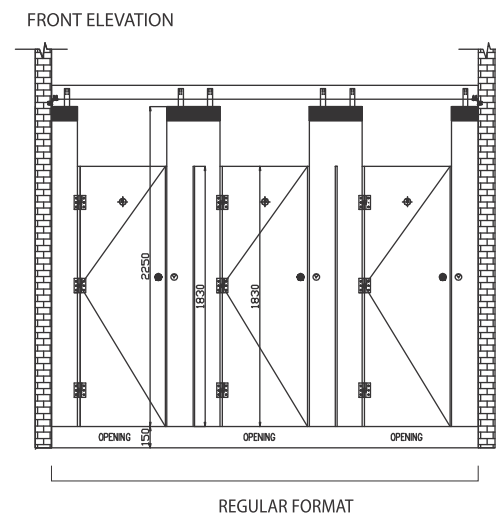
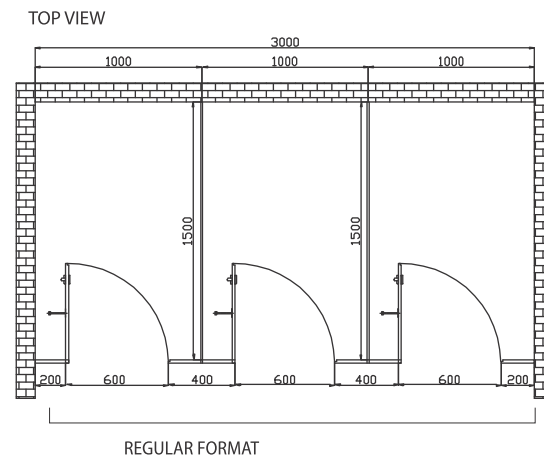

THE STRUCTURE

- The top supporting system runs above the ceiling to Strengthen & support the system. The aluminum hollow rectangle channel is first held above the false ceiling on both ends by MS L angle, which is fixed on to the wall with 3 set of quality steel wall plus c/w bolts.
- The ground clearance is 100 mm.
- The rectangle channel are distributed equally, in sync with the position of the pilaster and fixed into the hollow MS top rail using bolts and screws.
- Maintaining the floor clearance of 100 mm, each door is mounted on mid/end pilaster with 3 hinges.
- Each door has one coat hook and door knob affixed.
- Each mid/end pilaster coming at the free end of the door is furnished with one privacy thump-turn and one door-stopper channel to reduce the noise.
- Door opening could be set either from inside or outside and could be fixed on left or right side.

DIMENSIONS

Standard dimensions (mm)	Regular
Total cubicle height from ground	2400
Cubicle depth	1550
Pilaster height	1860
Pilaster width	150/300
Door height	1715
Door width	600
Top rail height	45
Bottom gap	100
HPL Thickness	12

SPECIAL FEATURES

- Hang Up arrangement gives absolute ground clearing to the restrooms
- 12 mm thick Compact Board makes the entire setup sturdier
- SS accessories



Privacy indicator/Knob

SS Coat hook

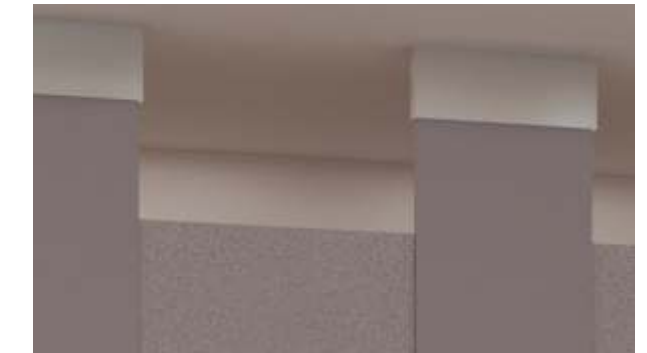

SS finish aluminum Top rail



absolute ground clearance

PROseries ROVE

ROVE - this new addition in the PRO series offers the clear floor concept that makes hygiene maintenance a fuss free task. This format of cubicles is formatted with 12mm compact laminates that provide sleekness and durability both. The cubicle accessories are in stainless steel with each door having one privacy thumb-turn and a doorstopper channel for the noise free experience. This series with its clear-floor neat contemporary look and durability works well in premium commercial spaces, sports arena, health clubs, gyms and spa.

PROPOSED APPLICATION AREAS

- commercial**
premium offices / high end shopping malls
- healthcare**
high end hospitals
- sports & wellness**
spa / sports clubs / gym

CUBICLE SYSTEMS



THE STRUCTURE

The D shaped Hollow aluminum Toprail (Grade 5063 T-6) is held to the concrete wall on both the ends by MS L angle, which is fixed to the wall with SS screws.

The front pilaster is fixed into the Toprail with SS screws inserted on the back side on Top rail

The ground clearance is 100 mm.

Intermediate Panels (partitions) are fixed to rear wall and mid pilaster through SS U-channels.

Maintaining the floor clearance of 100 mm, each door is mounted on mid/end pilaster with 3 hinges.

Each door has one coat hook and door knob affixed.

Each mid/end pilaster coming at the free end of the door is furnished with one privacy thump-turn and one door-stopper channel to reduce the noise.

- Door opening could be set either from inside or outside and could be fixed on left or right side.

DIMENSIONS

Standard dimensions (mm)	Regular
Total cubicle height from ground	2015
Cubicle depth	1550
Pilaster height	1860
Pilaster width	150/300
Door height	1715
Door width	600
Top rail height	45
Bottom gap	100
HPL Thickness	12

SPECIAL FEATURES

- Hang Up arrangement gives absolute ground clearing to the restrooms
- 12 mm thick Compact Board makes the entire setup sturdier
- SS Top rail arrangement for better stability and strength
- SS accessories

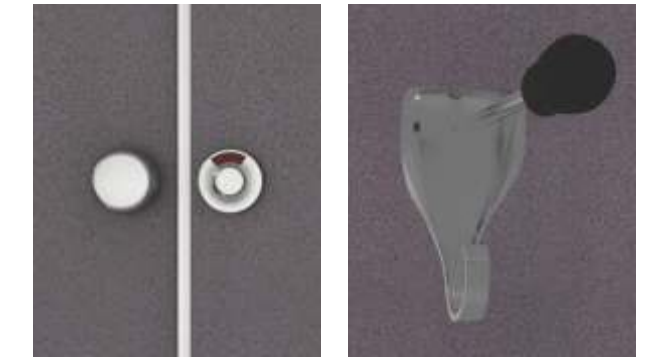

Privacy indicator/Knob

SS Coat hook



SS finish aluminum Top rail



absolute ground clearance

TOP VIEW

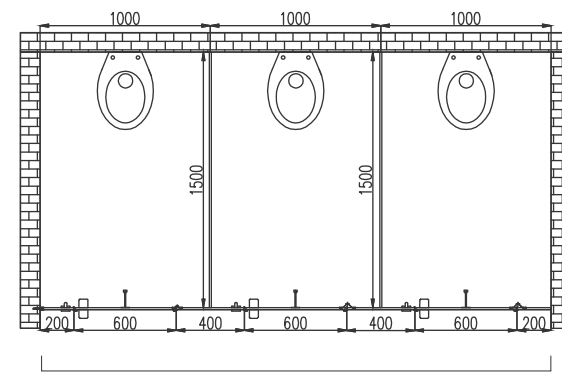

REGULAR FORMAT

FRONT ELEVATION

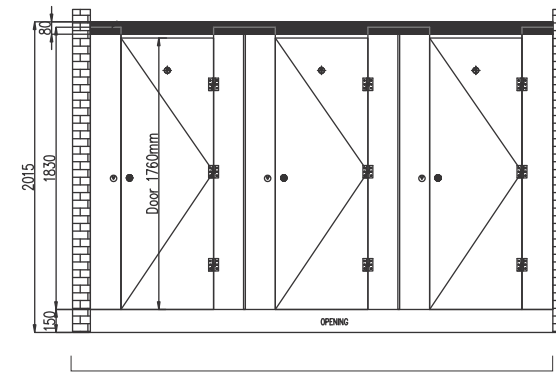

REGULAR FORMAT

ACE series NUVO

Less is more with the **NUVO/ACE series** cubicle series. These minimalistic design rest room cubicles are easy to construct, are economical exhibiting a simple sophistication. These systems come with adjustable nylon coated legs that give your restroom space a clean and neat look. Powder coated aluminum top rails gives you stability and durability at an economical price. The cubicle accessories like hinges, lockset indicator, hooks and door knobs are in nylon. Live minimalistic- live with NUVO.

PROPOSED APPLICATION AREAS

commercial
shopping malls / commercial complex

hospitality
restaurants

healthcare
hospitals / clinics

sports & wellness
stadium / sports clubs / gym
club houses

education
schools / collages / universities

CUBICLE SYSTEMS



THE STRUCTURE

- The adjustable legs (Nylon PA-6) are anchored on the floor so that the mid/end pilaster can be fixed on them.
- The base of leg is anchored to the floor with nylon plugs that are inserted into ground with SS screws.
- The adjustable legs provide floor clearance of 150 mm.
- Powder coated Aluminum top rail (Grade 6063-T% Alloy) is fixed to maintain alignment of all pilasters.
- Intermediate Panels (partitions) are fixed to rear wall and mid pilaster through aluminum U-channels.
- Maintaining the floor clearance of 150 mm, each door is mounted on mid/end pilaster with 3 hinges.
- Each door has one coat hook and door knob affixed.
- Each mid/end pilaster coming at the free end of the door is furnished with one privacy thump-turn and one door stopper channel to reduce the noise.
- Door opening could be set either from inside or outside and could be fixed on left or right side.

DIMENSIONS

Standard dimensions (mm)	Regular	Specially abled
Total cubicle height from ground	2055	2055
Cubicle depth	1550	1550
Pilaster height	1860	1860
Pilaster width	150/300	150/300
Door height	1815	1815
Door width	600	900
Top rail height	45	45
Bottom gap	150	150
HPL Thickness	12	12

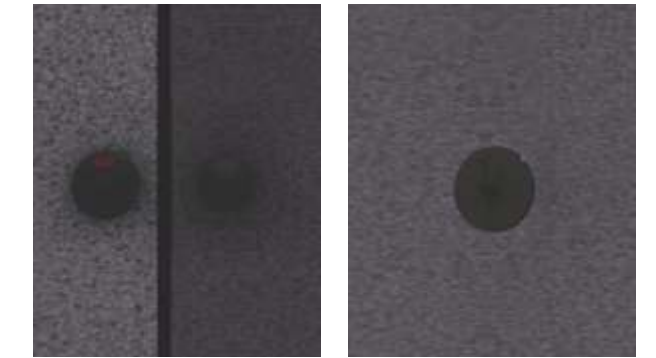
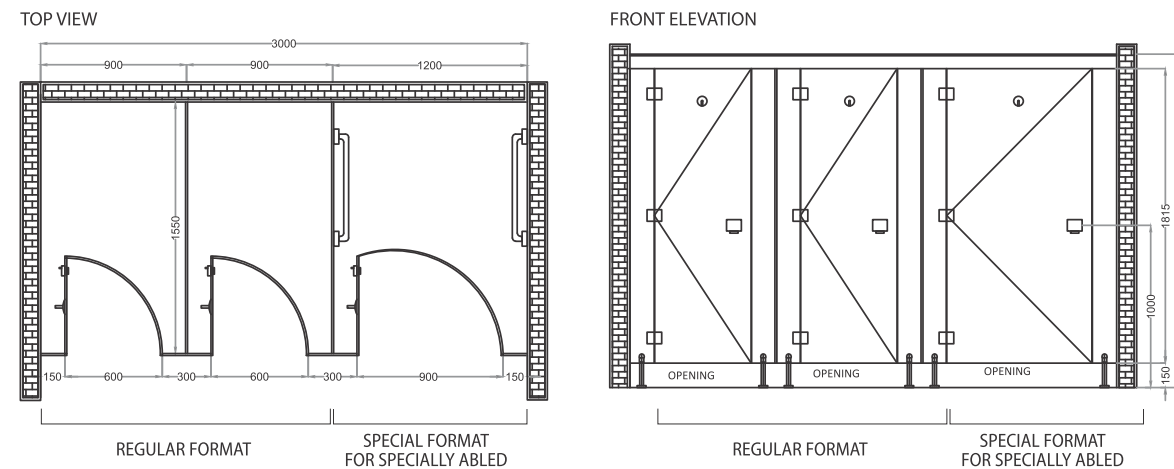

Privacy indicator/Knob

Nylon Coat hook



Powder coated aluminum Top rail



Adjustable Nylon Legs

SPECIAL FEATURES

- Adjustable nylon coated legs
- Powder coated aluminum Top rail arrangement for better stability, economy and aesthetics
- Nylon accessories (hinges, coat hook, adjustable foot, lock set indicator etc.)
- Nylon accessories available in three colour variants: White / Gray / Black



ACE series RORSO

Today's multiplexes, large commercial spaces and hospitals bear the wear and tear of a heavy footfall in their restrooms. In such busy restrooms, one wants sturdiness with sensibility. The **RORSO/ACE series** is your answer to strength and durability. The strength of this system comes from its powder coated robust aluminum round poles that also double up to give your restroom a creative soft edge. With cubicle accessories in nylon, they are easy on maintenance. The top rail arrangement in aluminum gives you stability and economy.

PROPOSED APPLICATION AREAS

commercial
shopping malls / commercial complex

hospitality
restaurants

healthcare
hospitals / clinics

sports & wellness
stadium / sports clubs / gym
club houses

education
schools / collages / universities

CUBICLE SYSTEMS

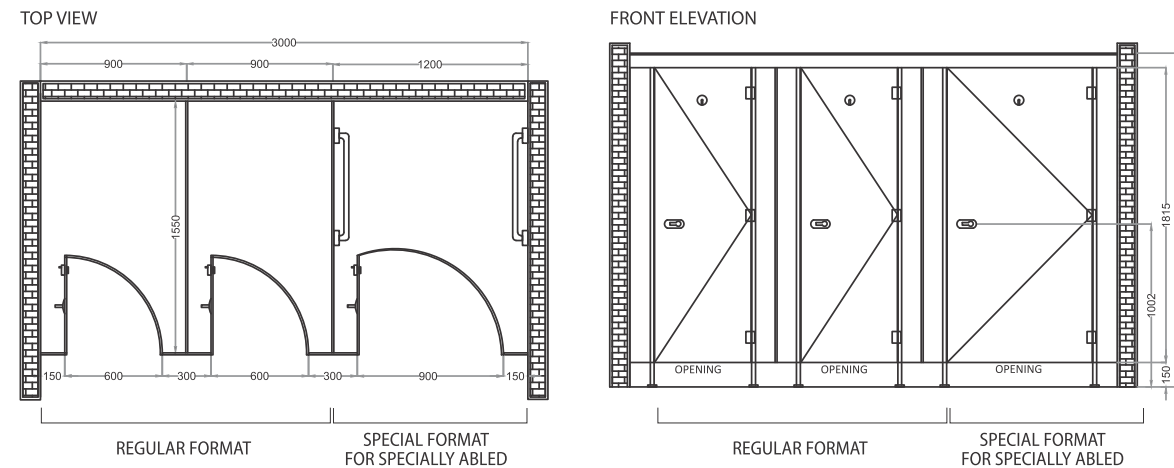

DIMENSIONS

Standard dimensions (mm)	Regular	Specially abled
Total cubicle height from ground	2055	2055
Cubicle depth	1550	1550
Pilaster height	1860	1860
Pilaster width	150/300	150/300
Door height	1815	1815
Door width	600	900
Top rail height	45	45
Bottom gap	150	150
HPL Thickness	12	12

THE STRUCTURE

- Powder coated robust aluminum Round poles with foot anchored are on the floor so that the mid/end pilaster can be fixed on them.
- The base of round pole leg is anchored to the floor with nylon plugs that are inserted into ground with SS screws.
- The adjustable M Pole legs provide floor clearance of 150 mm.
- Powder coated Aluminum top rail (Grade 6063-T% Alloy) is fixed to maintain alignment of all pilasters.
- Intermediate Panels (partitions) are fixed to rear wall and mid pilaster through aluminum U-channels.
- Maintaining the floor clearance of 150 mm, each door is mounted on round pole with 3 hinges.
- The round pole is affixed rubber sponge to reduce the noise.
- Each door has one coat hook and door knob affixed.
- Each mid/end pilaster coming at the free end of the door is furnished with one Latch Lock Set.
- Door opening could be set either from inside or outside and could be fixed on left or right side.

SPECIAL FEATURES

- Adjustable nylon/Aluminum coated M pole legs
- Powder coated aluminum Top rail arrangement for better stability, economy and aesthetics
- Nylon accessories (hinges, coat hook, adjustable foot, latch indicator etc.)
- Nylon accessories available in three colour variants: White / Gray / Black



Privacy indicator/Knob

Nylon Coat hook



Powder coated aluminum Top rail



Adjustable nylon/Aluminum coated M pole legs



ACE series ZONA

The **ZONA/ACE series** of cubicle systems is your answer when aesthetics and ease are needed in renovation projects. Using existing intermediate brick walls, this system fits in perfectly with its door arrangement. The 12mm thick, compact board doors come in varied designs and colours. This system wraps around matching pilaster, is slim and strong with high durability. They work well where speed of installation with minimal maintenance is needed in renovation projects.

PROPOSED APPLICATION AREAS

- commercial**
offices / commercial complex
- hospitality**
highway restuarants
- healthcare**
clinics
- sports & wellness**
stadium / sports clubs / gym / club houses

CUBICLE SYSTEMS



THE STRUCTURE

- Aluminum D-shaped poles are fixed in the wall on both sides with SS screws and wall plugs.
- Maintaining the floor clearance of 150 mm, each door is mounted on D-shaped pole with 3 hinges.
- The poles are affixed rubber sponge/lining to reduce the noise.
- Door opening could be set only from inside and could be fixed on left or right side.

SPECIAL FEATURES

- Doors made up of 12mm thick compact board
- Hardware and accessories available in Nylon + aluminum
- Slim and strong, highly durable system
- Wrap around matching pilaster
- Faster installation, maintenance friendly
- Nylon accessories available in three colour variants: White / Gray / Black



Privacy indicator/Knob



Coat hook

TOP VIEW

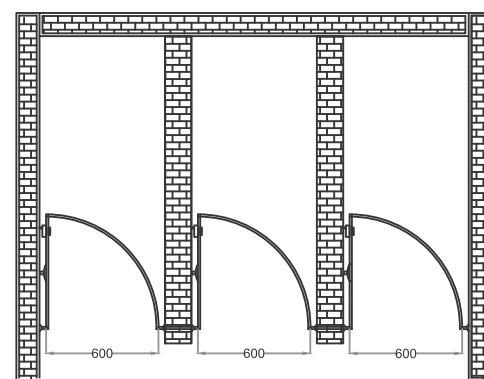

FRONT ELEVATION

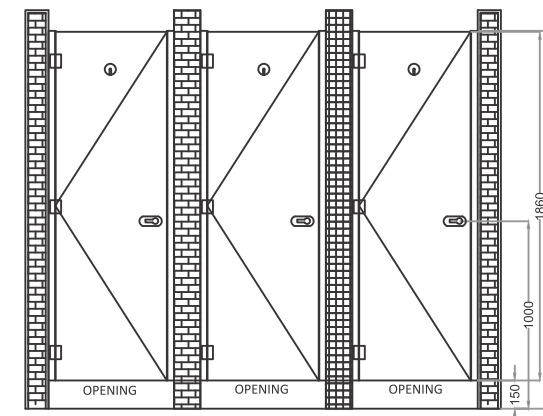

DIMENSIONS

Standard dimensions (mm)	Regular	Specially abled	
Total cubicle hight from ground	2010	The dimensions shall be as per existing intermediate brick walls setup.	
Door width	700/900		
Door hight	1860		
Bottom gap	150		150
HPL Thickness	12		12



ALPHA

DIVIDER PANELS

Restroom Divider Panels get a new name with CUBOID divider panels from the house of Stylum. These restroom Divider Panels (urinal partitions) come in vibrant colours and design, and are made with superior grade 12mm compact laminates that come with the seal of anti-bacterial and anti-fungie protection. Aside from hygiene, privacy is very important in these areas. Crafted as a single undivided piece with chamfered edges, these Divider Panels give your restroom space a clean and neat look. The material and colour can be perfectly attuned to the layout of the room and the cubicles.

PROPOSED APPLICATION AREAS

- commercial**
offices / shopping malls / commercial complex
- hospitality**
restaurants / hotels
- healthcare**
hospitals / clinics
- sports & wellness**
stadium / sports clubs / gym / spa / club houses
- education**
schools / collages / universities

URINAL PARTITIONS



THE STRUCTURE

- Each divider panel is equipped with SS L-clamp that attaches the divider to the wall.
- SU-304 screws are used for fixing the divider panel to the wall.
- The partition panels are manufactured using 12 mm thick compact laminate.
- As per international standards the gap of the divider from the ground should be 500-600 mm.

DIMENSIONS

Standard dimensions (mm)	Regular
Partition depth	550
Partition height	1200
Gap from ground	500-600
HPL thickness	12

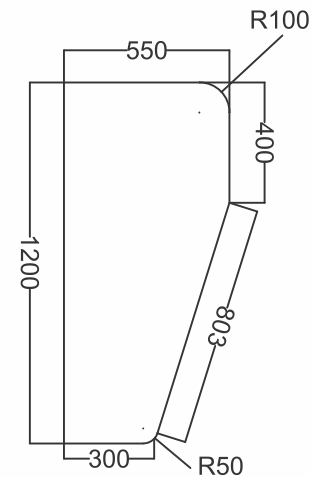

SUPPORT GRAB BAR SYSTEMS



CUBOID Support Grab bar system is an adaptable tube and connector system that facilitates productive custom-made design for support grab bars, guide railing and staircases where vertical post fixing is essential. The range consists of anti-corrosive nylon fixtures and high quality aluminum fittings.

All the products have been designed to provide utmost hygiene, easy maintenance, anti-static surface, sturdiness and stability. These heavy-duty grab bars are manufactured in accordance to ADA guidelines to provide firmness and added assistance to physically challenged. Available in both left and right handed version with plugs and screws.

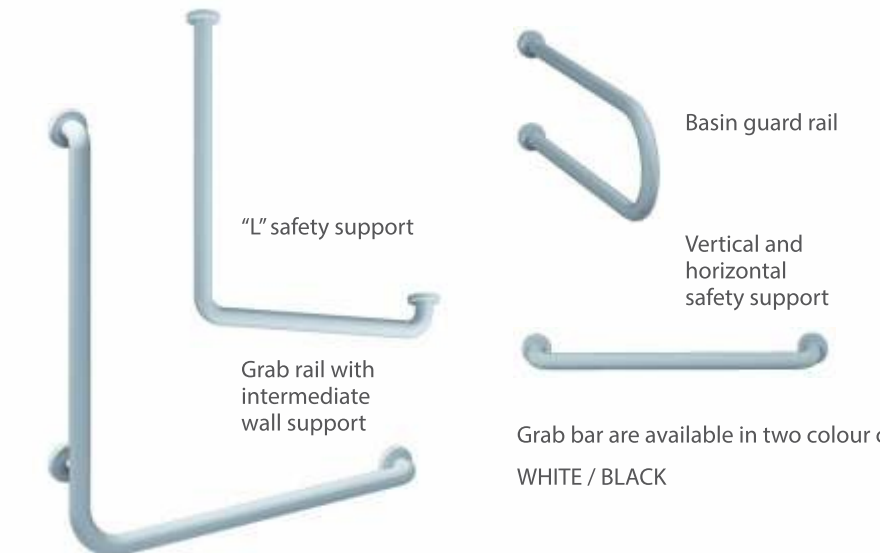

Grab bar are available in two colour choices: WHITE / BLACK

LOCKER SYSTEMS

VERSATILE.
FUNCTIONAL.
ROBUST.

Are you looking for eclectic, ultra-modern, yet functional and durable locker systems?

Presenting, the Cuboid smart solution locker systems made with Stylam compact laminates. Available in varied colours, designs, sizes, formats and specifications, they are the perfect fit to your locker requirements, interiors and services. These systems are sturdy, durable, environment friendly and easy to use.

These durable locker systems adapt well in high humidity zones like gymnasiums, spas, sauna centers, fitness clubs, swimming pools, commercial environments and fitness centers. The Stylam laminates used in these systems come with the Germ-Free protection Shield of "Anti-Bacterial & Anti-Fungie". The Germ-Free Shield ensures continuous protection against the development and proliferation of bacteria and guarantees a safe and hygienic surface.

KEY FEATURES

- Exceptional hygiene:
Anti-bacterial and anti-fungie properties of the laminate surface not just restrain the bacterial growth but also minimize the risk of spreading and transferring bacteria.
- Excellent resistance to vandalism
- Rust proof, scratch resistant and water resistant
- Faster and easy installation, maintenance friendly
- Excellent resistance to impact hence suitable for intensive usage

APPLICATION AREAS

EDUCATION

Schools/colleges
Labs
Library
Staff room

HEALTHCARE

Hospitals
Clinics

HOSPITALITY

Restaurants
Hotels
Resorts

SPORTS & WELLNESS

Swimming pools
Stadium
Sports clubs
Gym

THE CHOICES

1X -1 door module

2X -2 door module

3X - door module

4X - door module

5X - door module

Z - interlocking module

FINEST LOCKER SYSTEMS

THE BASE

Within CUBOID locker systems, we offer three base mechanisms to rest your locker units on. Pick the right one that best suits your purpose.

- SS legs
- Compact laminate skirting
- Concrete base

THE LOCKING MECHANISM

Old timer, transitional or modern-day. We have alternatives for the diverse needs and preferences.

- Customer Lock
- Inbuilt Key-Lock
- Numeric Lock (key less)

THE HINGES

In CUBOID locker systems, the hinges integrated into the aluminum frames has patented and vandal-proof design that carries a lifetime warranty. The 175 degree opening angle of the door assists easy access. Each locker is self-ventilated around the perimeter of the door where it meets the frame.

THE DOORS, WALLS & PARTITIONS

The CUBOID locker systems has doors, walls and partition panels made from solid phenolic HPL for excellent durability and remarkable water resistance.

9mm HPL Compact laminate is used for shelves to ensure robust structure.

9mm HPL Compact laminate door comes with integrated hinge design.

Back and side panels are made of 3mm board complementing the overall assembly of the unit

THE CHANNELS

CUBOID locker systems' integrated frames, threaded connectors and 'plug & screw' assembly escapes the need for glue or permanent fastening. Efficient to ship, easy and quick to install, a smart retro-fit. The entire system could be easily disassembled or reassembled without compromising the core materials. This what awards CUBOID a completely modular locker system.

THE CONSTRUCT

Mid shelves are supported through aluminum half round channel at all four corners.

Aluminum half round channels are fitted on outer most channels.

Note:

As Economy Solution, we offer 6mm HPL compact laminate for doors and shelves. In this module the mid shelves are supported through aluminum half round channel at two corners while MSU-clip at other two corners. Aluminum half round channels fitted on outer most channels are absent in economy model.

1X 1 DOOR MODULE

Standard dimensions	mm
Height of locker unit	1830
Width of locker unit	300
Depth of locker unit	450
Height of base	100



2X 2 DOOR MODULE

Standard dimensions	mm
Height of locker unit	914
Width of locker unit	300
Depth of locker unit	450
Height of base	100



3X 3 DOOR MODULE

Standard dimensions	mm
Height of locker unit	608
Width of locker unit	300
Depth of locker unit	450
Height of base	100



4X 4 DOOR MODULE

Standard dimensions	mm
Height of locker unit	455
Width of locker unit	300
Depth of locker unit	450
Height of base	100



5X 5 DOOR MODULE

Standard dimensions	mm
Height of locker unit	364
Width of locker unit	300
Depth of locker unit	450
Height of base	100



Z INTERLOCKING MODULE

Standard dimensions	mm
Height of locker unit	1327
Hanging height	500
Width of locker unit	300
Depth of locker unit	450
Height of base	100



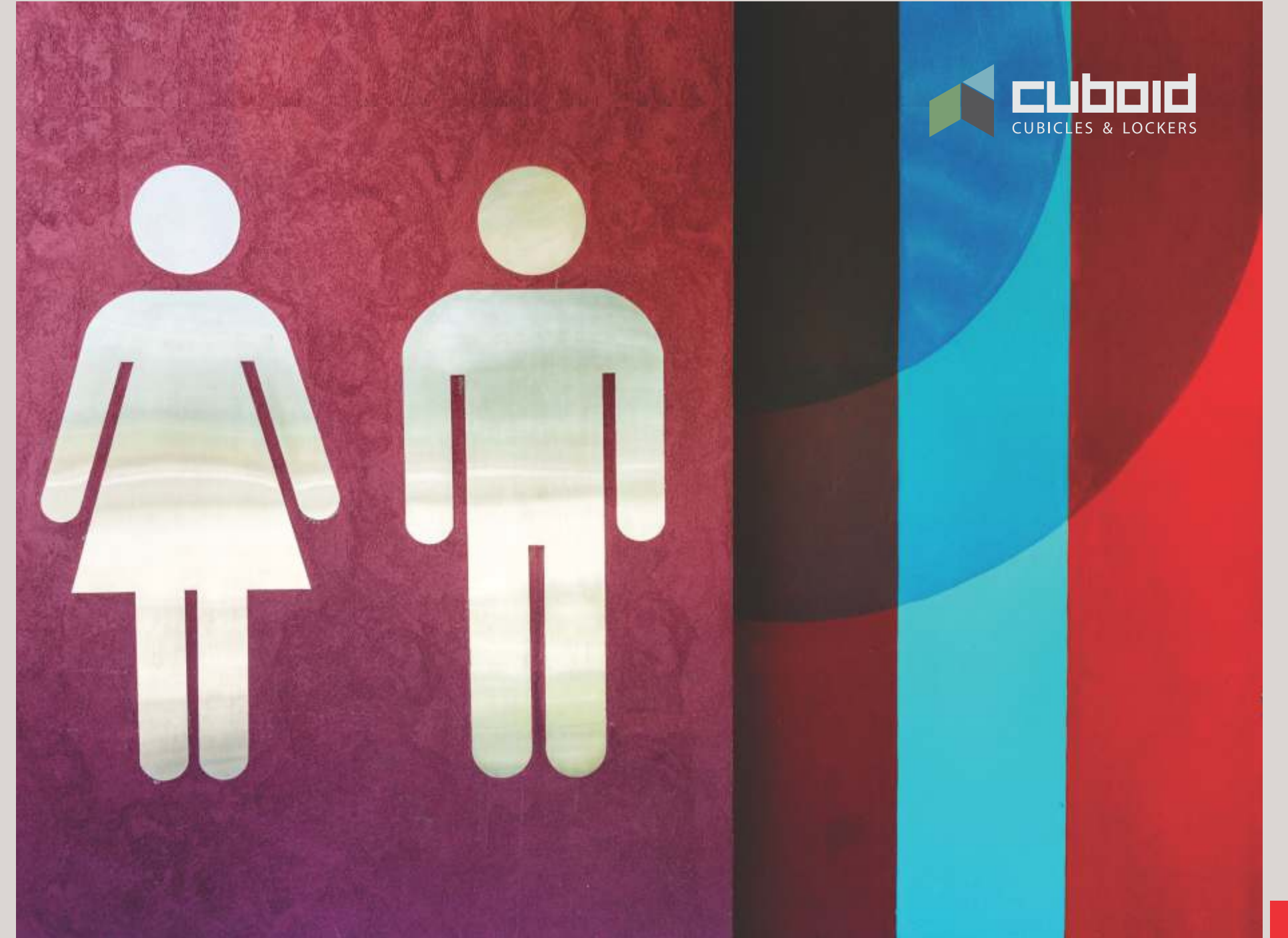

THE CUBOID ADVANTAGES



hygienic & safe



Attractive



resistant to
cigarette burns



impact resistant



quick installation



Environment
friendly

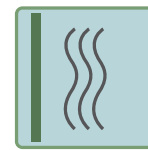

steam resistant

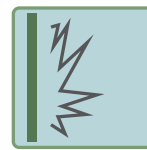

abrasion resistant



easy to
maintain



scratch resistant



wide range of
colours & designs



crack resistant



durable



moisture resistant



competitively
priced



solvent resistant



noise deafening
system

THE CONSTRUCT

PRINTED DESIGN COMPACT LAMINATE

Black core craft paper (treated with melamine resin)

Printed design paper (treated with melamine resin)

Over-layer paper for print décor
(treated with melamine resin)

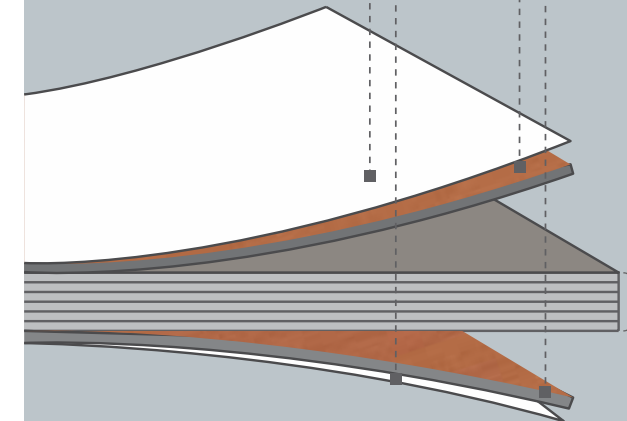

SOLID COMPACT LAMINATE

Black core craft paper (treated with melamine resin)

Solid design paper (treated with melamine resin)

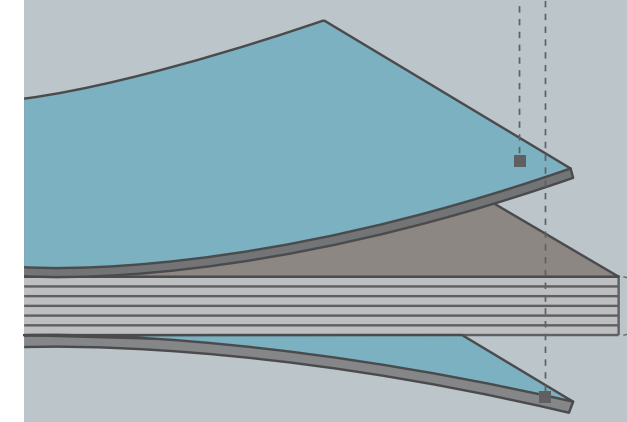

Compact Laminates with ANTI-BACTERIAL & ANTI-FUNGIE properties

- Retards 99.9% of fungal and bacterial growth on contact with the laminate.
- Backed by Green Guard Certification, and now with the Anti-Bacterial & Anti-Fungie protection, it will improve the indoor air quality by leaps and bounds.
- Meets the standards of ASTM G21 – 09 and ISO 22196 – 2007, which is based on JIS Z 2801.

WHY CUBOID

- 33 years of experience in HPL
- extensive product range
- product innovation with top design
- top quality material and processing
- professional installation on site
- prompt and on-schedule delivery
- Affordable and smart solutions
- one-stop service
- quick quotation processing

CUBICLE FORMATS AT A GLANCE



PROseries MAX

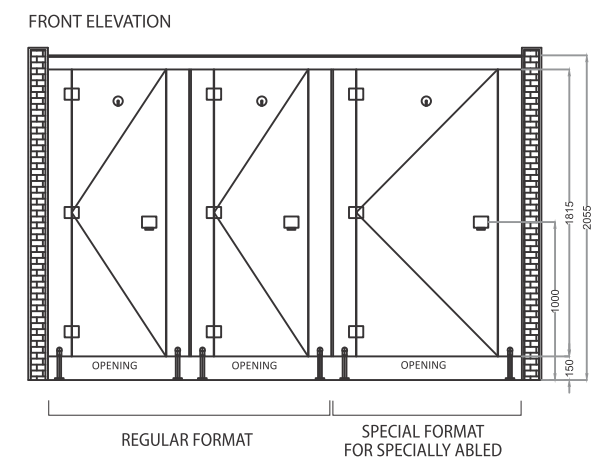
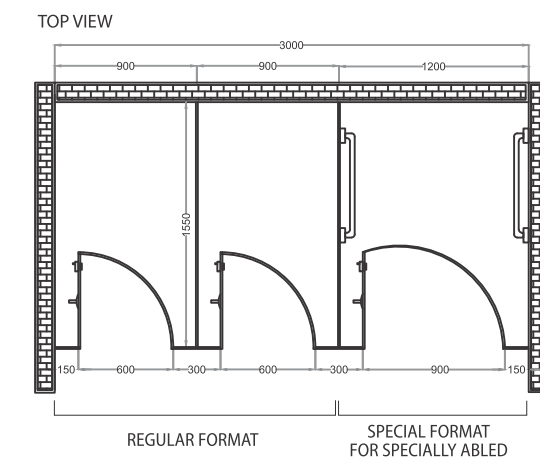

PROseries DURA

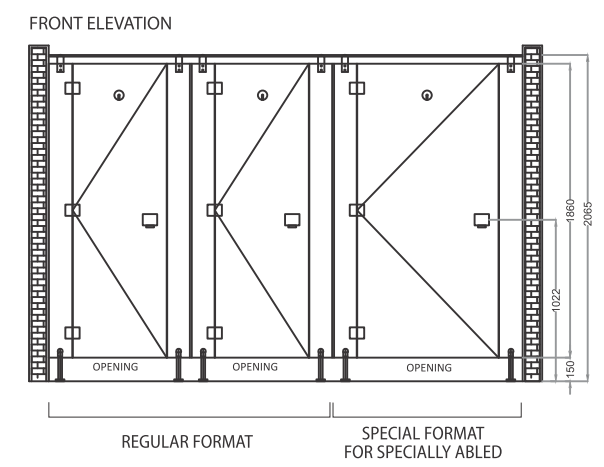
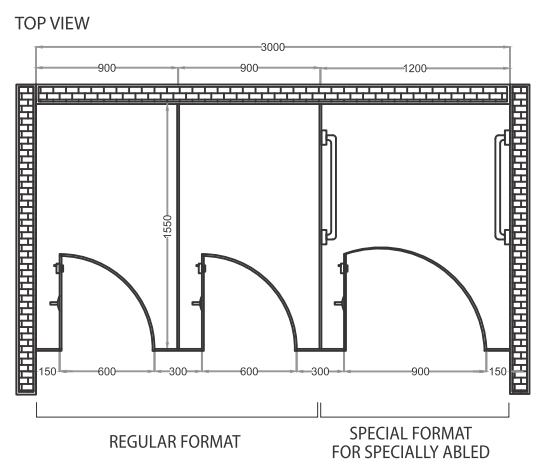

PROseries LORON

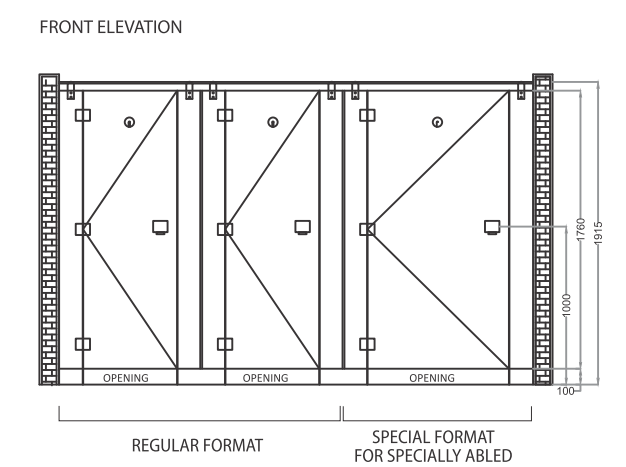
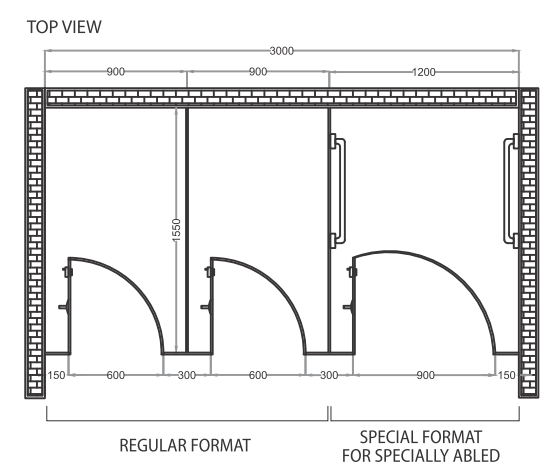

PROseries **LANTO**

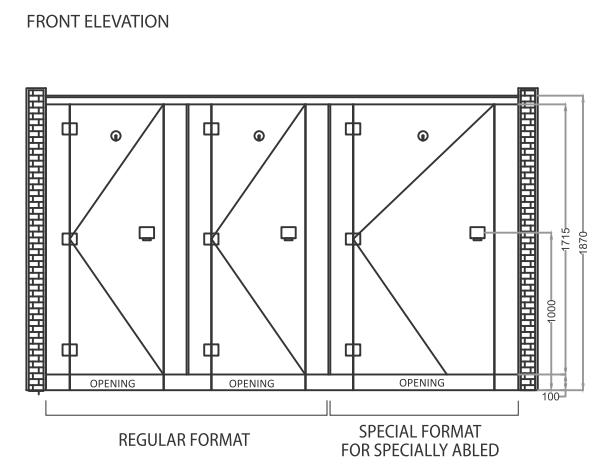
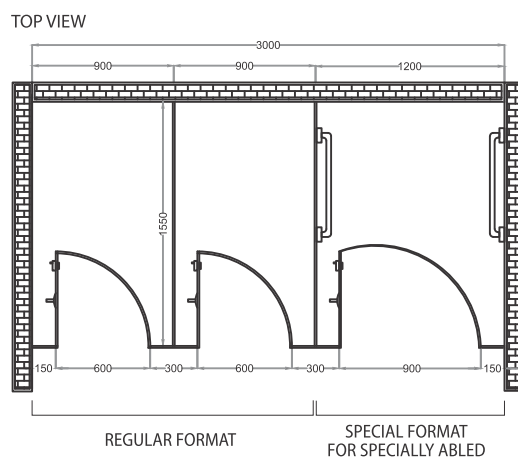

PROseries **ROVE**

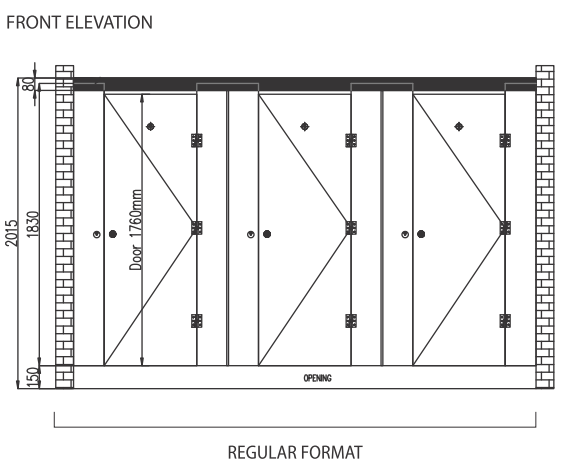
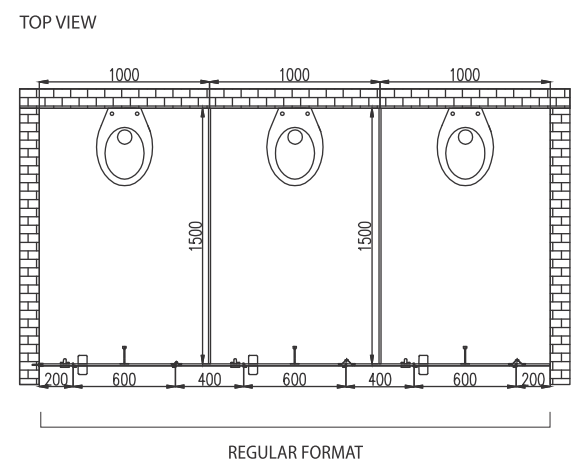

PROseries **HANGUP**

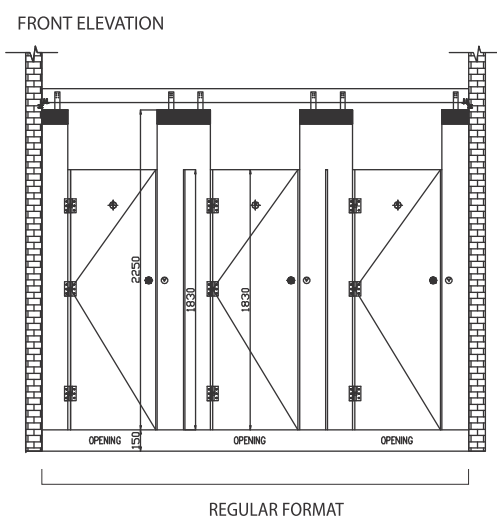
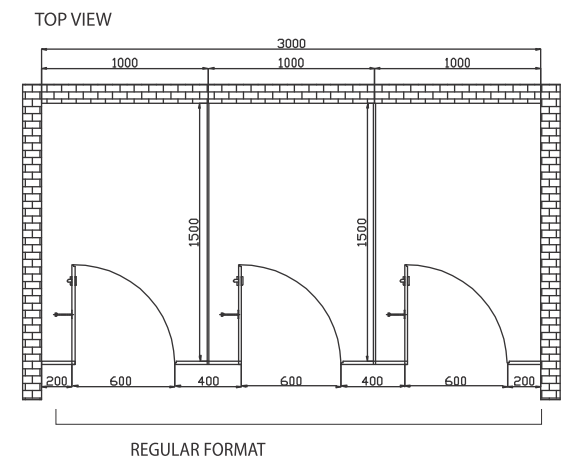

ACEseries **NUVO**

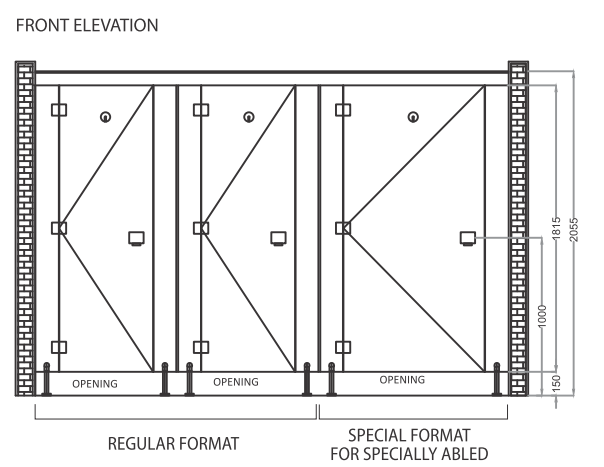
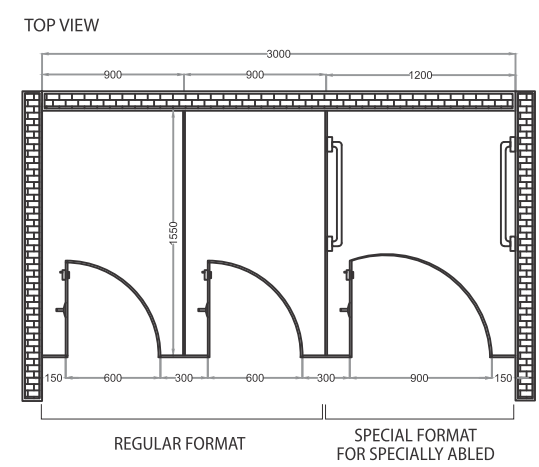

ACEseries **RORSO**

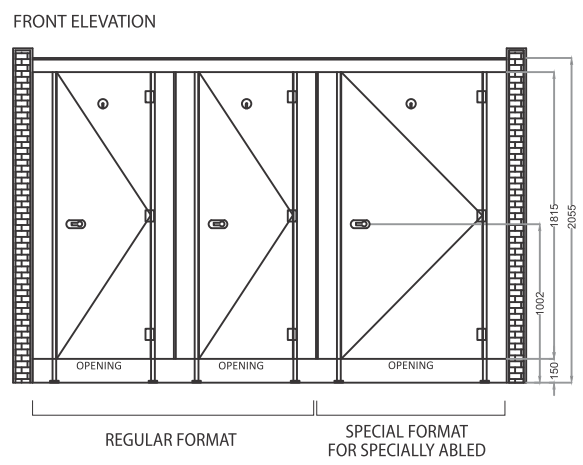
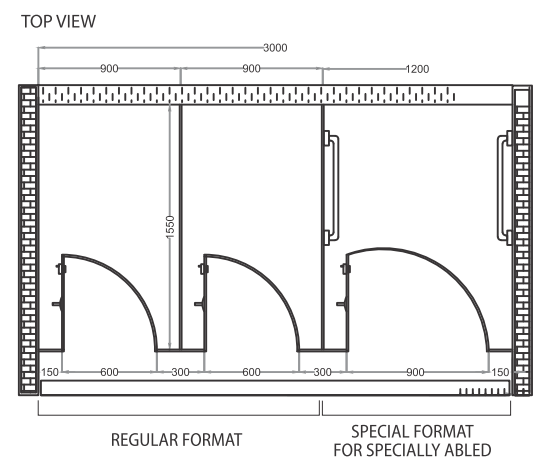

ACCESSORIES
GROCERY



D Pole Chanel
Material: Aluminum
Used in: Zona



Top Rail
Material: SS/Aluminum
Used in: Lanto, Max, Nuvo, Rorso



Lock
Material: Nylon
Used in: Zona, Rorso
Colour options: white, grey, black



F Chanel
Material: SS/Aluminum
Used in: Dura, Max, Loran, Lanto, Nuvo, Rorso, Rove, Hangup



Foot
Material: SS
Used in: Dura, Max



Lock
Material: Nylon
Used in: Nuvo
Colour options: white, grey, black



U Chanel
Material: SS/Aluminum
Used in: Dura, Max, Loran, Lanto, Nuvo, Rorso, Rove, Hangup



Foot
Material: Nylon
Used in: Nuvo
Colour options: white, grey, black



M Pole Foot
Material: Nylon, Aluminium
Used in: Rorso



Round Top Rail
Material: SS
Used in: Dura, Loran



Shoe Box
Material: SS
Used in: Loran (12mm), Lanto (18mm)



Tabular Holder
Material: SS
Used in: Dura, Loran

ACEseries **ZONA**

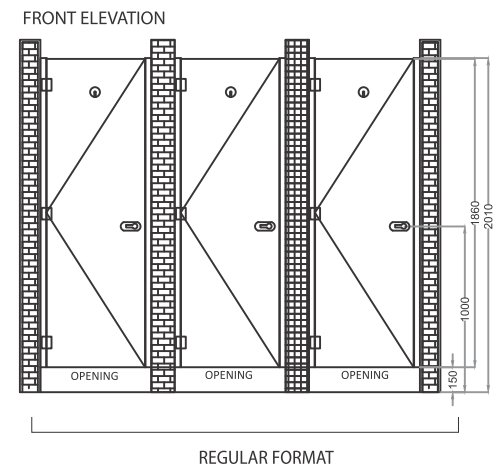
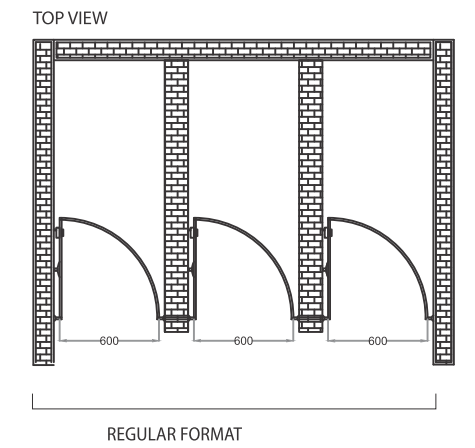

ACCESSORIES GROCERY



Top Rail Cocker
Material: SS / Nylon
Used in: Lanto, Nuvo, Rorso



Coat Hook
Material: Nylon
Used in: Nuvo, Rorso, Zona



Door Knob
Material: SS / Nylon
Used in: all models



End Connector
Material: SS
Used in: Dura, Loron



Wall Bracket
Material: SS
Used in: Dura, Loron



Hing
Material: SS / Nylon
Used in: all models



Coat Hook
Material: SS
Used in: Dura, Max, Loron, Lanto



L Clamp
Material: SS
Used in: Alpha Urinal Partitions

THE CERTIFICATES



TECHNICAL DATA



STYLAM COMPACT LAMINATES - CGS/CGF

Compact High Pressure Laminates (HPL) as per EN 438-4 : 2016, are available in the standard CGS and in the flame retardant CGF types on demand. When these laminates are self-supporting they are ready for installation.

SR. NO.	PROPERTIES	TEST METHOD	ATTRIBUTES OF PERFORMANCE	UNIT OF MEASUREMENT	RESULTS (AS PER EN 438-4)
			EN-438 Laminate Classification		CGS/CGF
1	SURFACE QUALITY				
1.1	Surface quality	EN 438-2.4	Spots, dirt and similar surface defects Fibres, hairs and scratches	mm ² /m ² mm/m ²	≤ 1 ≤ 10
2	DIMENSIONAL PROPERTIES				
2.1	Thickness	EN 438-2.5	Thickness tolerance	mm	2 ≤ T < 3 : ± 0,2
				mm	3 ≤ T < 5 : ± 0,3
				mm	5 ≤ T < 8 : ± 0,4
				mm	8 ≤ T < 12 : ± 0,5
				mm	12 ≤ T < 16 : ± 0,6
				mm	16 ≤ T < 20 : ± 0,7
				mm	20 ≤ T < 25 : ± 0,8
				mm	25 ≤ T : ± 1,3
2.2	Size	EN 438-2.6	Length and width	mm	+ 10 / - 0
2.3	Straightness of edges	EN 438-2.7	Straightness of edges	mm/m	≤ 1,5
2.4	Squareness	EN 438-2.8	Squareness	mm/m	≤ 1,5
2.5	Flatness	EN 438-2.9	Flatness (measured on full-size sheet)	mm/m	2,0 ≤ T < 6,0 : 8
				mm/m	6,0 ≤ T < 10,0 : 5
				mm/m	10,0 ≤ T : 3
3	PHYSICAL PROPERTIES				
3.1	Resistance to surface wear	EN 438-2.10	Wear Resistance - Initial Point	Revolutions	Unicolours - ≥ 150 Printed Décor - ≥ 125
3.2	Resistance to immersion in boiling water	EN 438-2.12	Mass increase - 2 ≤ T < 5 mm	%	CGS - ≤ 5 , CGF - ≤ 7
			Mass increase - T ≥ 5 mm	%	CGS - ≤ 2 , CGF - ≤ 3
			Thickness increase - 2 ≤ T < 5 mm	Rating	CGS - ≤ 6 , CGF - ≤ 9
			Thickness increase - T ≥ 5 mm	Rating	CGS - ≤ 2 , CGF - ≤ 6
			Appearance - Gloss Finish	Rating	≥ 3
			Appearance - Other Finishes	Rating	≥ 4
3.3	Resistance to water vapour	EN 438-2.14	Appearance - Gloss Finish	Rating	≥ 3
			Appearance - Other Finishes	Rating	≥ 4
3.4	Resistance to dry heat (160°C)	EN 438-2.16	Appearance - Gloss Finish	Rating	≥ 3
			Appearance - Other Finishes	Rating	≥ 4
3.5	Dimensional stability at elevated temperatures	EN 438-2.17	Cumulative dimensional change - 2 ≤ T < 5mm	L %	≤ 0,40
				T %	≤ 0,80
			Cumulative dimensional change - T ≥ 5mm	L %	≤ 0,30
				T %	≤ 0,60
3.6	Resistance to impact with large diameter ball	EN 438-2.21	Indent. dia. 10mm 2 ≤ T < 6 mm - Drop	mm	≥ 1400
			Indent. dia. 10mm T ≥ 6mm - Drop Height	mm	≥ 1800
3.7	Resistance to crazing	EN 438-2.24	Appearance	Rating	≥ 4
3.8	Resistance to scratching	EN 438-2.25	Appearance - Smooth Finishes	Rating	≥ 2
			Appearance - Textured Finishes	Rating	≥ 3
3.9	Resistance to staining	EN 438-2.26	Appearance - Group 1 & 2	Rating	≥ 5
			Appearance - Group 3	Rating	≥ 4
3.10	Light fastness (Xenon arc)	EN 438-2.27	Contrast	Grey scale rating	4 to 5
3.11	Flexural modulus	EN ISO 178	Stress	Mpa	≥ 9000
3.12	Flexural strength	EN ISO 178	Stress	Mpa	≥ 80
3.13	Density	EN ISO 1183	Density	gm/cm ³	≥ 1,35
4	FIRE PERFORMANCES				
			Test as per EN 13823 (SBI test) and EN ISO 11925-2 (Small-burner test)		
4.1	Fire Reaction Classification, CGF	EN 13501	Classification - 3 ≤ T < 6 mm	Rating	B - s2, d0
			Classification - T ≥ 6 mm	Rating	B - s1, d0
4.2	Fire Reaction Classification, CGS	EN 13501	Classification - 6 ≤ T < 10 mm	Rating	D - s1, d0
			Classification - T ≥ 10 mm	Rating	B - s1, d0
5	OTHER PROPERTIES				
5.1	Release of Formaldehyde	EN 438-7.4.11.1	Classification	Rating	E1

Disclaimer :

This Product Technical Sheet gives technical information relevant to the performance of product as tested by STYLAM and External Certified testing agencies. STYLAM reserves the right to change product composition and characteristics at any time.



DURA		
S. NO.	ITEM DESCRIPTION	Approved Make
1.00	PARTITIONS AND ASSOCIATED WORKS	
1.00	Toilet Cubical	DURA BY STYLAM
	<p>Providing & fixing STYLAM CUBOID DURA Toilet Cubicle (of following standard dimension which includes 600mm door size width) made of heat, bacteria, water, chemical, scratch, impact and anti bacterial resistant 12mm thick solid compact laminate panels tested by national test house. Finish of the compact laminate should be Suede, which includes doors, pilasters & intermediate panels finished with approved texture/shade as per the detail drawings & as per IS 2046 (Indian Standard) and as per fire retardant BS-476/97 standard. The product should have Green Guard Certificate.</p> <p>This also includes providing and fixing in position necessary hardware made out of Stainless steel (Grade 304) as per manufacturer's specifications & Architects instructions like (1) Door Knob, (2) Gravity Hinges, (3) Thumb turn lockset with Occupancy indicators, (4) Coat hooks with Door stopper (5) U-Channels, (6) Adjustable Legs/pedestal(Grade 316), (7) Top rail with Corner connector (8) Rubber noise deafening tape, (9) Screws & wall Plugs.</p> <p>The top fitting should consist of SS round top rail which will get fixed with pilasters, with SS panel tube holder, SS corner bend (connected with top rail) will be used on the corner of cubicle in absence of brick wall, SS wall fixing is used only on the wall which will hold the ss top rail.</p> <p>All screws will of 304 Grade in stainless steel with satin finish. All pilasters are supported by stainless steel Bottom Cladding. The base of the stainless steel bottom cladding will be anchored to the floor with a clearance height upto 150mm.</p>	
1.01	Toilet Cubicle with standard dimension of 2065mm Height x 1000mm Width x 1550mm Depth, which includes 600mm door size width).	
1.02	Toilet Cubicle I-Shape (Front Partition) with standard dimension of 2065mm Height x 1000mm Width which includes 600mm door size width).	

MAX								
BILL OF QUANTITIES FOR TOILET BLOCK WORK								
S. NO.	ITEM DESCRIPTION	APPROVED MAKE	BASIC PRICE	REMARKS	QUANTITY	UNIT	RATE	AMOUNT
				FLOOR	TOTAL			
1.00	PARTITIONS AND ASSOCIATED WORKS							
1.00	Toilet Cubical							
	<p>Providing & fixing STYLAM - CUBOID - MAX Toilet Cubicle (of following standard dimension which includes 600mm door size width) made of heat, bacteria, water, chemical, scratch, impact and anti bacterial resistant 12mm thick solid compact laminate panels tested by national test house. Finish of the compact laminate should be Suede, which includes doors, pilasters & intermediate panels finished with approved texture/shade as per the detail drawings & as per IS 2046 (Indian Standard) and as per fire retardant BS-476/97 standard. The product should have Green Guard Certificate.</p> <p>This also includes providing and fixing in position necessary hardware made out of Stainless steel (Grade 304) & Aluminium powder coated top rail as per manufacturer's specifications & Architects instructions like (1) SS Door Knob, (2) SS Gravity hinges, (3) SS Thumb turn lockset indicators, (4) Aluminum Powder Coated Top Rail, (5) SS Coat Hooks, (6) SS U-Channels, (7) SS Adjustable Foot, (8) Noise Deafening Tape etc. (9) Screws & wall Plugs.</p> <p>The top fitting should consist of Aluminium Powder Coated top rail which will get fixed with Mid & End pilasters.</p> <p>All other hardware & screws will of stainless steel in 304 Grade with satin finish. Top rail is extruded Aluminium will be powder coated or anodized (Grade 6063 Micron Aluminium). All pilasters are supported by stainless steel adjustable footing with non corrosive steel inserts.</p>	MAX BY STYLAM						
1.01	Toilet Cubicle with standard dimension of 2055mm Height x 1000mm Width x 1550mm Depth, which includes 600mm door size width).					Nos		
1.02	Toilet Cubicle I-Shape (Front Partition) with standard dimension of 2055mm Height x 1000mm Width which includes 600mm door size width).					Nos		

LORON								
BILL OF QUANTITIES FOR TOILET BLOCK WORK								
S. NO.	ITEM DESCRIPTION	APPROVED MAKE	BASIC PRICE	REMARKS	QUANTITY	UNIT	RATE	AMOUNT
				FLOOR	TOTAL			
1.00	PARTITIONS AND ASSOCIATED WORKS							
1.00	Toilet Cubical							
	<p>Providing & fixing STYLAM CUBOID LORON Toilet Cubicle (of following standard dimension which includes 600mm door size width) made of heat, bacteria, water, chemical, scratch, impact and anti bacterial resistant 12mm thick solid compact laminate panels tested by national test house. Finish of the compact laminate should be Suede, which includes doors, pilasters & intermediate panels finished with approved texture/shade as per the detail drawings & as per IS 2046 (Indian Standard) and as per fire retardant BS-476/97 standard. The product should have Green Guard Certificate.</p> <p>This also includes providing and fixing in position necessary hardware made out of Stainless steel (Grade 304) as per manufacturer's specifications & Architects instructions like (1) Door Knob, (2) Gravity Hinges, (3) Thumb turn lockset indicators, (4) Coat hooks, (5) U-Channels, (6) SS-Shoe Box Plate (7) MS-Base Plate, (8) Top rail with Corner connector (9) Rubber noise deafening tape (10) Screws & wall Plugs.</p> <p>The top fitting should consist of SS round top rail which will get fixed with pilasters, with SS panel tube holder, SS corner bend (connected with top rail) will be used on the corner of cubicle in absence of brick wall, SS wall fixing is used only on the wall which will hold the ss top rail.</p> <p>All screws will of 304 Grade in stainless steel with satin finish. All pilasters are supported by stainless steel Bottom Cladding. The base of the stainless steel bottom cladding will be anchored to the floor with a clearance height upto 110mm.</p>	LORON BY STYLAM						
1.01	Toilet Cubicle with standard dimension of 1915mm Height x 1000mm Width x 1550mm Depth, which includes 600mm door size width).					Nos		
1.02	Toilet Cubicle I-Shape (Front Partition) with standard dimension of 1915mm Height x 1000mm Width which includes 600mm door size width).					Nos		

LANTO								
BILL OF QUANTITIES FOR TOILET BLOCK WORK								
S. NO.	ITEM DESCRIPTION	APPROVED MAKE	BASIC PRICE	REMARKS	QUANTITY	UNIT	RATE	AMOUNT
				FLOOR	TOTAL			
1.00	PARTITIONS AND ASSOCIATED WORKS							
1.00	Toilet Cubical							
	<p>Providing & fixing STYLAM CUBOID LANTO Toilet Cubicle (of following standard dimension which includes 600mm door size width) made of heat, bacteria, water, chemical, scratch, impact anti bacterial resistant 18mm thick solid compact laminate panel tested by national test house. Finish of the compact laminate should be Suede, which includes doors, pilasters & intermediate panels finished with approved texture/shade as per the detail drawings & as per IS 2046 (Indian Standard) and as per fire retardant BS-476/97 standard. The product should have Green Guard Certificate.</p> <p>This also includes providing and fixing in position necessary hardware made out of Stainless steel (Grade 304) as per manufacturer's specifications & Architects instructions like (1) Door Knob, (2) Gravity Hinges, (3) Thumb turn lockset indicator, (4) Coat hook, (5) U-Channels, (6) SS-Shoe Box Plate (7) MS-Base Plate, (8) Rubber noise deafening tape (9) Screws & wall Plugs.</p> <p>All screws will of 304 Grade in stainless steel with satin finish. All pilasters are supported by MS-Base steel Bottom Cladding with Stainless Steel Shoe Box Plate. The base of the stainless steel shoe box will be anchored to the floor with a clearance height upto 110mm. Fixing of intermediate panels to the wall shall be stainless steel 'L' - Bracket or stainless U-Channel section are fixed into wall with screw inserts.</p>	LANTO BY STYLAM						
1.01	Toilet Cubicle with standard dimension of 1870mm Height x 1000mm Width x 1550mm Depth, which includes 600mm door size width).							
1.02	Toilet Cubicle I-Shape (Front Partition) with standard dimension of 1870mm Height x 1000mm Width which includes 600mm door size width).							

HANGUP								
BILL OF QUANTITIES FOR TOILET BLOCK WORK								
S. NO.	ITEM DESCRIPTION	APPROVED MAKE	BASIC PRICE	REMARKS	QUANTITY	UNIT	RATE	AMOUNT
				FLOOR	TOTAL			
1.00	PARTITIONS AND ASSOCIATED WORKS							
1.00	Toilet Cubical							
	<p>Supplying & fixing in position Stylam- Toilet Cubicle (of following standard dimension which includes 600mm door size width) made of heat, bacteria, water, chemical, scratch, impact and anti bacterial resistant 12mm & 18mm thick solid compact laminate panels tested by national test house. Finish of the compact laminate should be Suede , which includes doors, pilasters & intermediate panels finished with approved texture/shade as per the detail drawings & as per IS 2046 (Indian Standard) and as per fire retardant BS-476/97 standard. The product should have Green Guard Certificate.</p> <p>This also includes providing and fixing in position necessary hardware made out of Stainless steel (Grade 304) & With MS Supporting systems (1) SS Door Knob, (2) SS Gravity hinges, (3) SS Latch Indicator, (4) MS Top Support , (5) SS Coat Hook, (6) SS U-Channels, (7) SS-Shoe Box Plate , (8) Noise Deafening Tape etc. (9) Screws & wall Plugs.</p> <p>The top supporting system will run above the ceiling to Strengthen & support the system, it will be settled on end wall with MS 'L' angles Mid & End pilasters will be fixed with the top support.</p> <p>All other hardware & screws will of stainless steel in 304 Grade with satin finish.</p>	HANGUP BY STYLAM						
1.01	Toilet Cubicle with standard dimension Front 18mm thick with 2400 Height x 1000mm Width (Door Size 600mmx1830mm), Partition 12mm thick 1550mm Depth x 1930mm height (Including gap of 100mm), which includes 600mm door size width).							
1.02	Toilet Cubicle I-Shape (Front Partition) with standard dimension of 18mm thick, 2400mm Height x 1000mm Width, which includes 600mm x 1830mm door size width).							

ROVE								
BILL OF QUANTITIES FOR TOILET BLOCK WORK								
S. NO.	ITEM DESCRIPTION	APPROVED MAKE	IMAGE					
1.00	PARTITIONS AND ASSOCIATED WORKS							
1.00	Toilet Cubical							
	<p>Supplying & fixing in position Stylam Toilet Cubicle (of following standard dimension which includes 600mm door size width) made of heat, bacteria, water, chemical, scratch impact and anti bacterial resistant 12mm thick solid compact laminate panels tested by national test house. Finish of the compact laminate should be suede, which includes doors, pilasters & intermediate panels finished with approved texture/shade as per the detail drawings & as per IS 2046 (Indian Standard) and as per fire retardant BS-476/97 standard. The product should have Green Guard Certificate.</p> <p>TThis also includes providing and fixing in position necessary hardware made out of Aluminium (Grade -6063-T6) & SS 304 GRADE with Aluminium supporting systems (1) Door Knob, (2) Gravity Hinges, (3) Latchlock indicators, (4) Coat hooks, (5) U-Channels, (6) Top rail, (7) Door stopper channel, (8) Noise deafening tape etc (9) Screws (stainless steel in 304 Grade with satin finish)& wall Plugs.</p> <p>The top supporting system will run on the concrete wall to strengthen & support the systems,it will be settled on end wall with MS 'L' angles Mid & End pilasters will be fixed with the top support...</p>	ROVE BY STYLAM						
1.01	Toilet Cubicle with standard dimension of 2015mm Height x 1000mm Width x 1550mm Depth, which includes 600mm door size width).							
1.02	Toilet Cubicle I-Shape (Front Partition) with standard dimension of 2015mm Height x 1000mm Width which includes 600mm door size width).							
All aspects specified by the manufactures, Stylam Model or equivalent.								

NUVO								
BILL OF QUANTITIES FOR TOILET BLOCK WORK								
S. NO.	ITEM DESCRIPTION	APPROVED MAKE	BASIC PRICE	REMARKS	QUANTITY	UNIT	RATE	AMOUNT
				FLOOR	TOTAL			
1.00	PARTITIONS AND ASSOCIATED WORKS							
1.00	Toilet Cubical							
	<p>Providing & fixing STYLAM CUBOID-NUVO Toilet Cubicle (of following standard dimension which includes 600mm door size width) made of heat, bacteria, water, chemical, scratch, impact and anti bacterial resistant 12mm thick solid compact laminate panels , Finish of the compact laminate should be Suede / *Raw Silk, which includes doors, pilasters & intermediate panels tested by national test house. finished with approved texture/shade as per the detail drawings & as per IS 2046 (Indian Standard) and as per fire retardant BS-476/97 standard. The product should have Green Guard Certificate.</p> <p>This also includes providing and fixing in position necessary hardware made out of Nylon Polyamide Grade-6 & Aluminium powder coated top rail as per manufacturer's specifications & Architects instructions like (1) Door Knob, (2) Gravity Hinges, (3) Thumb turn lockset indicator, (4) Aluminum Top Rail, (5) Coat Hook, (6) U-Channels, (7) Adjustable Foot, (8) Noise Deafening Tape (9) Screws & wall plugs etc.</p> <p>The top fitting should consist of Aluminium Powder Coated top rail which will get fixed with Mid & End pilasters.</p> <p>All screws will of 304 Grade in stainless steel with satin finish. Top rail is extruded Aluminium will be powder coated or anodized (Grade 6063 Micron Aluminium). All pilasters are supported by grade- 6 Nylon Polyamide Thermoplastic palm design pedestal footing with non corrosive steel inserts. The base diameter 65mm and neck diameter of 33mm anchored to the floor with grade 304 satin finish stainless steel screws with push fit capping at a clearance height of 150mm. Model is Heat and Bacteria Resistant Polyamide in which aluminium U-Channel will be used for the fixing of intermediate panels to the wall.</p>	NUVO BY STYLAM						
1.01	Toilet Cubicle with standard dimension of 2055mm Height x 1000mm Width x 1550mm Depth, which includes 600mm door size width).							
1.02	Toilet Cubicle I-Shape (Front Partition) with standard dimension of 2055mm Height x 1000mm Width which includes 600mm door size width).							

RORSO								
BILL OF QUANTITIES FOR TOILET BLOCK WORK								
S. NO.	ITEM DESCRIPTION	APPROVED MAKE	BASIC PRICE	REMARKS	QUANTITY	UNIT	RATE	AMOUNT
				FLOOR	TOTAL			
1.00	PARTITIONS AND ASSOCIATED WORKS							
1.00	Toilet Cubical							
	<p>Providing & fixing STYLAM CUBOID RORSO Toilet Cubicle (of following standard dimension which includes 600mm door size width) made of heat, bacteria, water, chemical, scratch, impact and anti bacterial resistant 12mm thick solid compact laminate panels tested by national test house. Finish of the compact laminate should be Suede , which includes doors, pilasters & intermediate panels finished with approved texture/shade as per the detail drawings & as per IS 2046 (Indian Standard) and as per fire retardant BS-476/97 standard. The product should have Green Guard Certificate.</p> <p>This also includes providing and fixing in position necessary hardware made out of Nylon Polyamide Grade-6 & Aluminium powder coated top rail as per manufacturer's specifications & Architects instructions like (1) Verticle Post Door Channel (anodized), (2) Hinges Adaptors, (3) Gravity Hinges (4) Privacy Thumbturn c/w Occupancy Indicator, (5) Coat Hook, (6) Door Knob, (7) Noise Deafening Tape (8) Screws & wall Plugs.</p> <p>The Top rail should be extruded Aluminium which should be powder coated or anodized (Grade 6063 Micron Aluminium). Pilaster to be supported and frame with 50mm diameter vertical post with circular vertical poll foot and Intermediate panel is anchored to the wall with powder coating or anodized aluminium U & F Channel. Door panel should be fixed by 80mm diameter vertical post with noise deafening tape. All screws will of 304 Grade in stainless steel with satin finish.</p>	RORSO BY STYLAM						
1.01	Toilet Cubicle with standard dimension of 2055mm Height x 1000mm Width x 1550mm Depth, which includes 600mm door size width).							
1.02	Toilet Cubicle I-Shape (Front Partition) with standard dimension of 2055mm Height x 1000mm Width which includes 600mm door size width).							

ZONA								
BILL OF QUANTITIES FOR TOILET BLOCK WORK								
S. NO.	ITEM DESCRIPTION	APPROVED MAKE	BASIC PRICE	REMARKS	QUANTITY	UNIT	RATE	AMOUNT
				FLOOR	TOTAL			
1.00	PARTITIONS AND ASSOCIATED WORKS							
1.00	Toilet Cubical							
	<p>"Providing & fixing STYLAM CUBOID ZONA Toilet Cubicle (of following standard dimension which includes 600mm door size width) made of heat, bacteria, water, chemical, scratch, impact and anti bacterial resistant 12mm thick solid compact laminate panels tested by national test house. Finish of the compact laminate should be Suede , which includes doors, pilasters & intermediate panels finished with approved texture/shade as per the detail drawings & as per IS 2046 (Indian Standard) and as per fire retardant BS-476/97 standard. The product should have Green Guard Certificate.</p> <p>This also includes providing and fixing in position necessary hardware made out of Nylon Polyamide Grade-6 & Aluminium powder coated top rail as per manufacturer's specifications & Architects instructions like (1) D Post Door Channel (anodized), (2) Hinges Adaptors, (3) Gravity Hinges (4) Privacy Thumbturn c/w Occupancy Indicator, (5) Coat Hook, (6) Door Knob, (7) Noise Deafening Tape (8) Screws & wall Plugs.</p> <p>All the hardware shall be made of polyamide-6 material. Aluminium D-Post channel of 40mm dia which should be fixed to the wall with SS-304 screws, Door is gripped with the poles by an arrangement of hinge adaptor & hinges. Aluminium poles are incorporated with the rubber strip to reduce the noise effect."</p>	ZONA BY STYLAM						
1.01	Toilet Cubicle with standard dimension of 1980mm Height x 600mm to 900mm Width.					Nos		
*Raw silk finish is available on special demand.								

OUR CLIENTS



DMRC (Kanpur, Delhi & Agra Metro Work)



NCRTC (Delhi - Meerut Rail)



AAI (Gwalior, Jodhpur)



NHSRCL (Sabarmati Railway Station)



CPWD (Central Vista Project)



Indian Railways (New Delhi, Ghaziabad & More)



Maharishi Markandeshwar University (Mullana)



Plaksha University

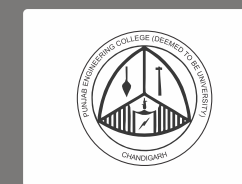

Punjab Engineering College



Jubilee Walk (Mohali)



Central Park 67 (Mohali (Cp67))



BHEL (Noida 16 Office)



Venus Remedies



OP Jindal Global University



Comfort Inn



AIIMS (Bilaspur)



Netsmartz



Elante Mall (Chandigarh)



SAMSUNG